



T&S BRASS AND BRONZE WORKS, INC.
 2 SADDLEBACK COVE / P.O. BOX 1088 / TRAVELERS REST, SC 29690
 PHONE 800-476-4103 - FAX 864- 834-3518



Model No.

B-0133-ADF08-B

**RELIABILITY
BUILT IN**

Job Name:

Architect/Engineer Approval:

Notes:

EPAct2005 COMPLIANT

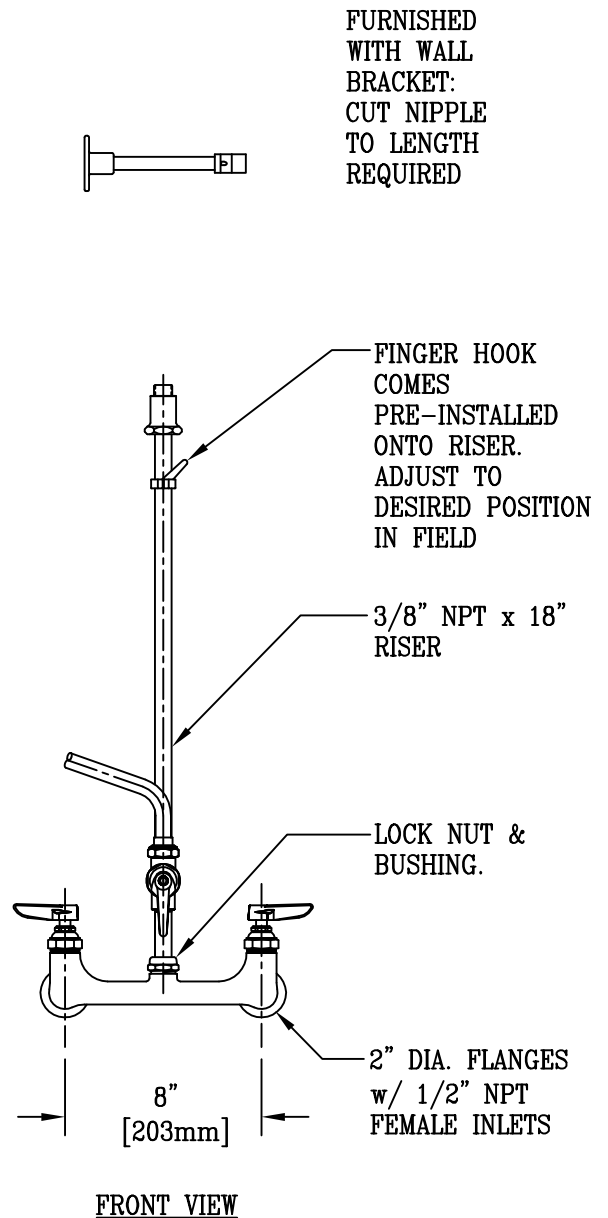
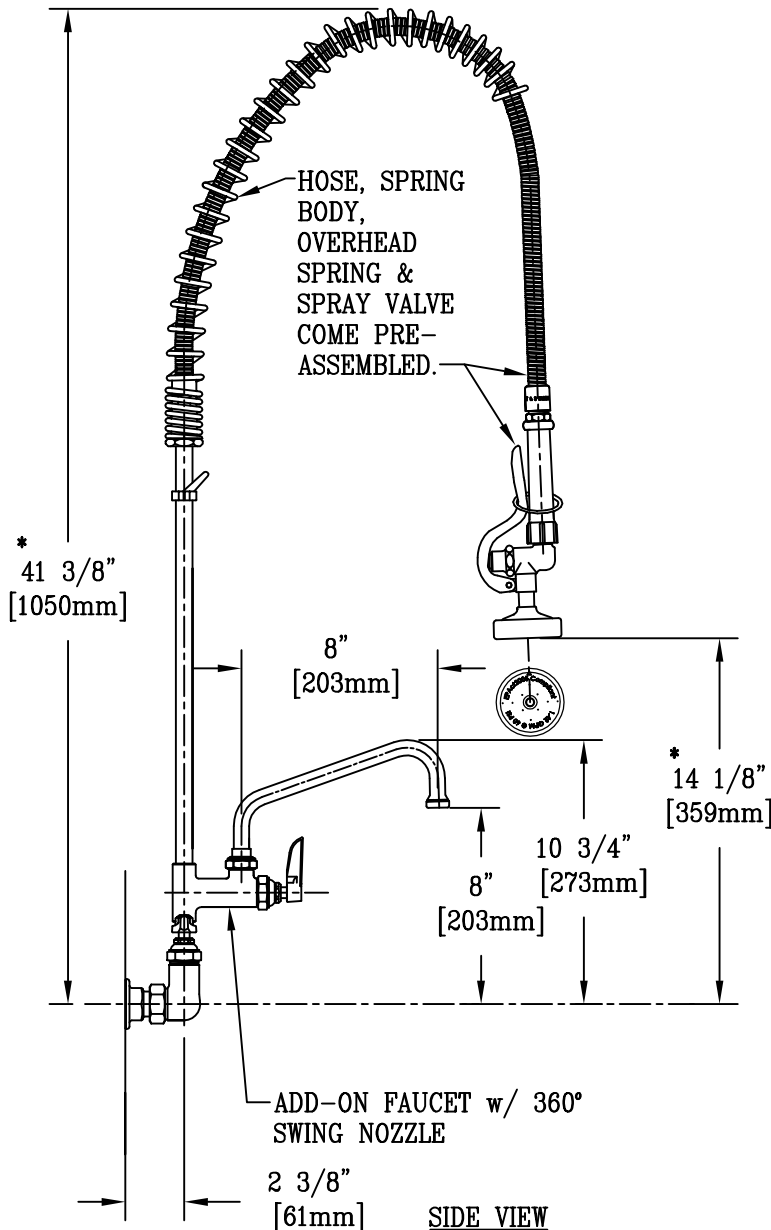

FURNISHED WITH WALL BRACKET: CUT NIPPLE TO LENGTH REQUIRED

* DIMENSIONS MAY VARY ± 1/2" ON EACH INSTALLATION

Product Description:
 EASY INSTALL PRE-RINSE UNIT:
 8" c/c WALL MOUNT BASE FAUCET, 1/2" NPT FEMALE INLETS, 18" RISER,
 ADD ON FCT., 8" SWING NOZZLE, SUPPORT SPRING, 44" FLEX HOSE, B-0107 SPRAY

Drawn: RJK	Checked JRM	Scale: 1 : 8
Approved JHB	Date: 01-04-06	